

P R O D U C T S



S H O W C A S E





DMG is a leading global lift component manufacturer. We redefine lift technology and design with top-tier products, advanced IoT solutions, and unmatched industry expertise.

Our product range includes complete fixtures, pushbuttons, multimedia systems, position indicators, touchless solutions, electronic devices, and complete electric systems.

With 50+ years of experience, we offer product excellence and innovative solutions. Lean manufacturing underpins our production, blending efficiency and flexibility.

Passion, unwavering dedication to our clients, a strong emphasis on design, and technological excellence form the cornerstone of our work.

● Production Sites

DMG Italy  
DMG China  
DMG India  
MAD Canada

● Offices

DMG Italy HQ  
DMG France  
DMG Germany



# DARDO

Push-buttons



- ✓ Frontal mounting with metal collar (no studs)
- ✓ Flush mounting with welded studs
- ✓ With or without tactile Braille
- ✓ Pressel AISI 304 stainless steel



Push-button profile H=23mm

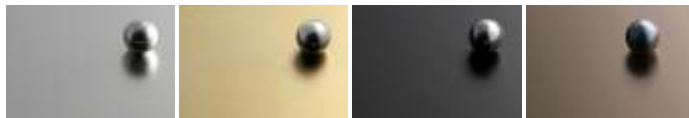

Stainless Steel PVD gold PVD black PVD bronze

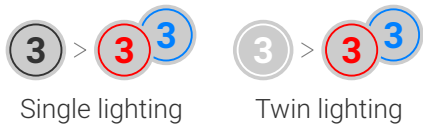

Single lighting Twin lighting

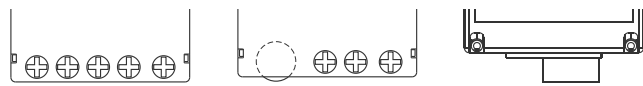

Screw terminals Screw terminals + acoustic feedback JST connector



# MACRO

Push-buttons



- ✓ Frontal mounting with metal collar (no studs)
- ✓ Flush mounting with welded studs (32 mm version only)
- ✓ Tactile Braille
- ✓ 35 or 32 mm cut-out round button
- ✓ Pressel AISI 304 stainless steel



Push-button profile H=23mm



Stainless Steel PVD gold PVD black

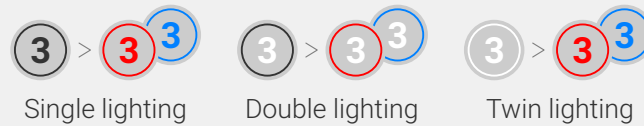

Single lighting Double lighting Twin lighting



Screw terminals Screw terminals + acoustic feedback JST connector



# BL

Push-buttons



- ✓ Frontal mounting with metal collar (no studs)
- ✓ Flush mounting with welded studs
- ✓ Tactile Braille option (square shape)
- ✓ Outer ring available in many shapes
- ✓ Pressel AISI 304 stainless steel



Push-button profile H=23mm

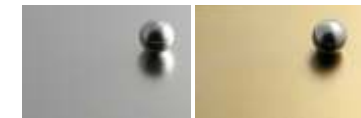

Stainless Steel PVD gold



Single lighting Double lighting Twin lighting

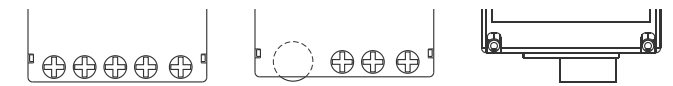

Screw terminals Screw terminals + acoustic feedback JST connector



# DISCO

Push-buttons



- ✓ Frontal mounting with metal collar (no studs)
- ✓ Tactile Braille
- ✓ Pressel AISI 304 stainless steel



Push-button profile H=16mm



Stainless Steel



Single lighting

Screw terminals

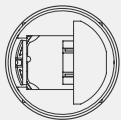
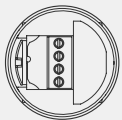

JST connector



# PANZER

Push-buttons

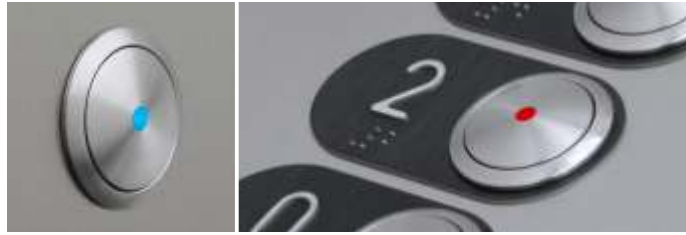

- ✓ Frontal mounting (no studs)
- ✓ Pressel AISI 303 stainless steel
- ✓ The PANZER button can be matched to:
  - BRUTUS electro-coloured stainless steel surrounds
  - CAESAR retro-illuminated stamped metal surrounds
  - EDGE illuminated tactile symbols
  - Stainless steel tags with tactile Braille

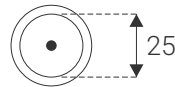

Push-button profile H=23mm

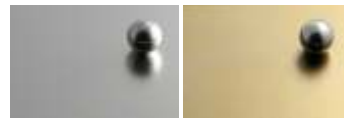

Stainless Steel PVD gold

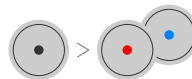

Single lighting



Screw terminals

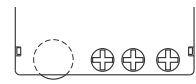

Screw terminals + acoustic feedback

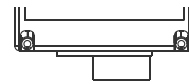

JST connector



# SHERMAN

Push-buttons

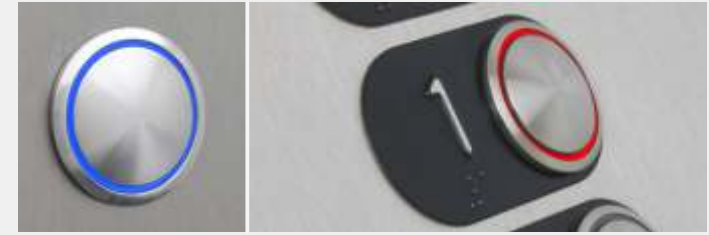

- ✓ Same features as the Panzer button
- ✓ Pressel AISI 303 stainless steel
- ✓ Four shapes available:



Classic



Disc



Moon



California



Push-button profile H=23mm

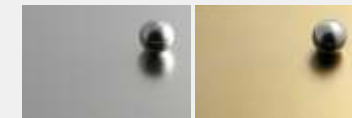

Stainless Steel PVD gold



Single lighting



Screw terminals



Screw terminals + acoustic feedback

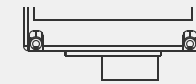

JST connector



# SHERMAN TouchLess

Push-buttons



- ✓ Frontal mounting (no studs)
- ✓ Same dimensions of the traditional Sherman button
- ✓ Mechanical activation also available if needed
- ✓ Touchless function based on "IR reflective" technology
- ✓ Limits touched surfaces, protecting against viruses and bacteria
- ✓ Pressel AISI 303 stainless steel



Push-button profile H=23mm

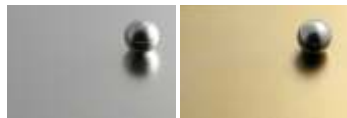

Stainless Steel PVD gold



Single lighting



Screw terminals



# B7 MAXXI

Push-buttons



- ✓ Frontal mounting with metal collar (no studs)
- ✓ Tactile Braille
- ✓ Anti-fingerprints shotpeen st/steel
- ✓ Outer ring available also in raised version against involuntary activation
- ✓ EN81-70 version available
- ✓ EN81-71 class1 version available, also IP54 protected



Push-button profile H=23mm



Stainless Steel PVD gold PVD black St/st White



Single lighting

Double lighting



Screw terminals



# Toe-To-Go

Push-buttons



- ✓ Frontal mounting by visible screws
- ✓ External cover easily interchangeable
- ✓ Wire in Parallel to Existing Buttons
- ✓ Hands-Free Activation
- ✓ Pressel AISI 304 stainless steel

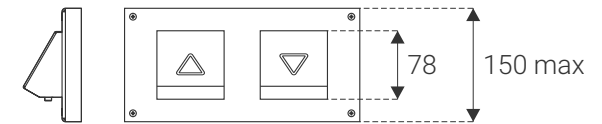

Push-button profile H=23mm



Stainless Steel

Not illuminated



Screw terminals



# KEY contacts

Components



## KABA key contact

- ✓ Flush or Low profile version
- ✓ Wiring through pin connector
- ✓ Mounted with or without Brutus bezel
- ✓ Halo can be illuminated with red Led

## EUROCYLINDER key contact

- ✓ Flush or Low profile version
- ✓ Wiring through jst connector
- ✓ Red Led illumination
- ✓ Both horizontal and vertical mounting

## VIRO key contact

- ✓ Frontal mounting without screws or welded studs
- ✓ Screw terminals wiring
- ✓ Red Led illumination

# EDGE illuminated symbol

Components



- ✓ It can be combined with any push-button or used as a floor marking
- ✓ Single or double digit
- ✓ With or without Braille
- ✓ Daisy-chain wiring via connector

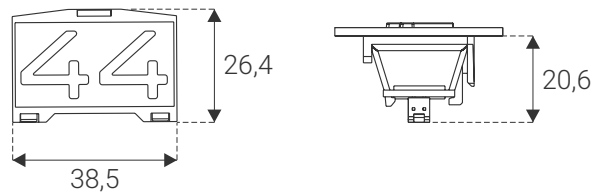

Lighting color



EN  
81-70

# EM-Light

Components



- ✓ 6 high-efficiency white LEDs
- ✓ Designed to comply with EN 81-20/50
- ✓ High resistance shell compliant to EN 81-71 / EN 81-72



DOT version

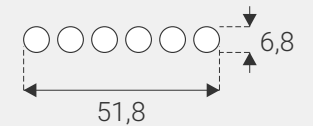

BAR version

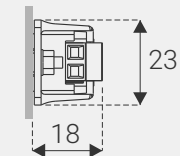
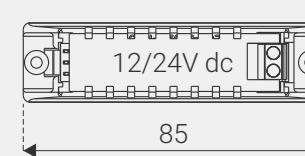
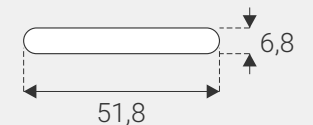

IPX3

# AMIGO emergency telephone

Electronic devices



- ✓ Remote programming
- ✓ 6 phone numbers storage capacity
- ✓ 10 recordable voice service messages
- ✓ Messages preloaded for 6 languages
- ✓ Intercom link to machine room and floor devices
- ✓ "Alarm sent" and "Communication established" visual indicators
- ✓ Optional GSM/4G module
- ✓ 12V DC Power supply
- ✓ Battery charger (optional)
- ✓ Inductive loop function available (option)
- ✓ Horizontal / Vertical supporting plate

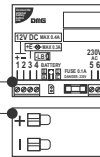

Additional slave devices can be placed on top/bottom of car or in the pit

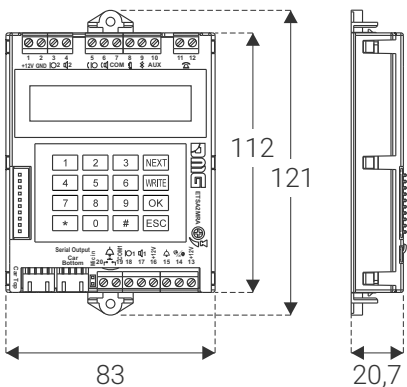

# TELEMACO 4G modem-router

Electronic devices



- ✓ 3G/4G Modem-Router with external SIM
- ✓ Enables full cloud-based connectivity for Pitagora 4.0 & Junior 4.0 controllers and Matisse multimedia displays
- ✓ Allows GSM voice communication for Amigo II phones (or third parties emergency phones)
- ✓ Can be configured from remote via SMS
- ✓ Integrated battery

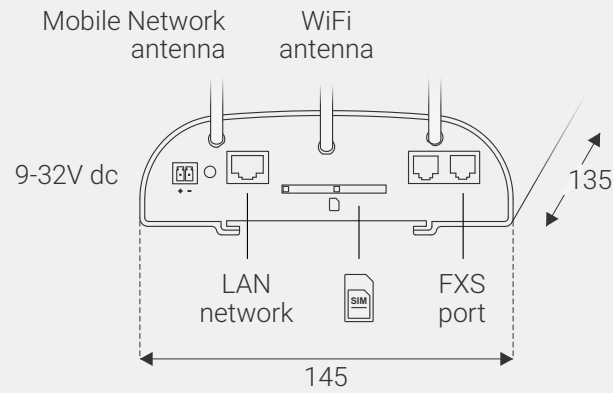

# CARUSO voice annunciator

Electronic devices



- ✓ Pre-loaded message libraries (8 languages + 1 custom)
- ✓ Factory pre-loaded floor messages
- ✓ 4-wires DMG serial link
- ✓ 7 configurable inputs for service messages
- ✓ Embedded speaker (IP54)
- ✓ Supported audio formats: mp3, wav
- ✓ 12/24V DC Power supply
- ✓ Automatic dual language mode (i.e.: "First floor" & "Premier étage")
- ✓ Manual Dual Message mode (i.e.: "First floor" + "Restaurant")
- ✓ USB port for additional messages and firmware updates
- ✓ Output for external loudspeaker

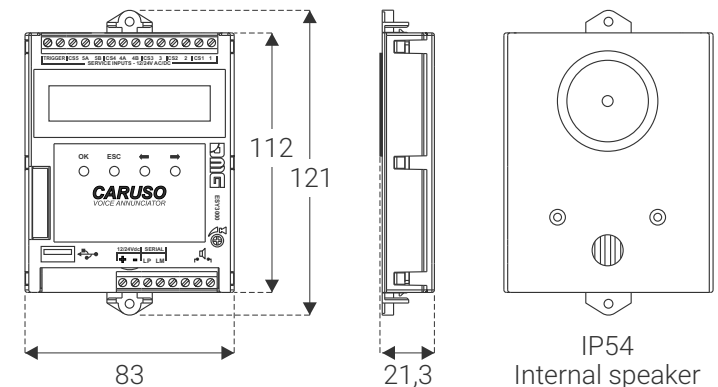



## LLEC7 lift overload device

Electronic devices



- ✓ Programming via Smartphone with **FUSION** APP
- ✓ Pre-calibrated sensors for easier installation
- ✓ It can manage up to 8 single sensors
- ✓ 3 thresholds relays
- ✓ Display of weight and output voltage of single load sensors
- ✓ Automatic compensation of car dynamic load during travel
- ✓ Adjustable compensation of travelling shaft cable weight
- ✓ IPX3 protection through the external cover

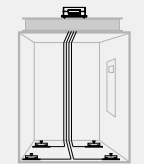
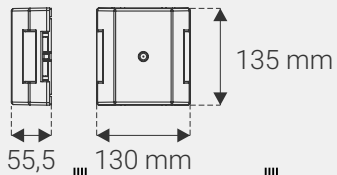

Sensors for car bottom



Sensor for car frame



Sensors for single rope



Sensor for multiple ropes



## MIRO' digital nameplate

Electronic devices



- ✓ High resolution fully customised TFT nameplate
- ✓ Flush mounted on plate
- ✓ Easy update with "Mosaic" PC software & USB key
- ✓ Up to 8 MIRO' nameplates per row can be connected

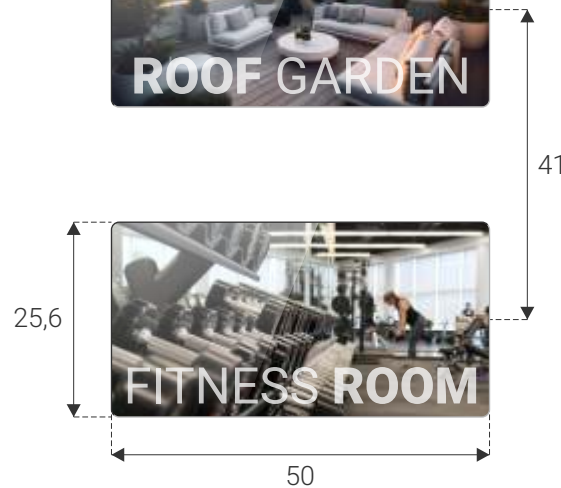

## SmartKEY PLUS electronic key

Electronic devices



- ✓ Electronic Key for car and protected floors
- ✓ Configure keys via Smartphone (iOS, Android), PC (Windows) and Web ("Fusion" Dashboard)
- ✓ Easy managing of users for big buildings through the cloud based "Fusion" APP
- ✓ Selectable modes:
  - 1) button enabling, 2) direct call, 3) constant pressure
- ✓ Fits into BLS, Panzer and Sherman cut outs
- ✓ Acoustic and visible key reading feedback
- ✓ 500 storable electronic keys (5 Master key max.)

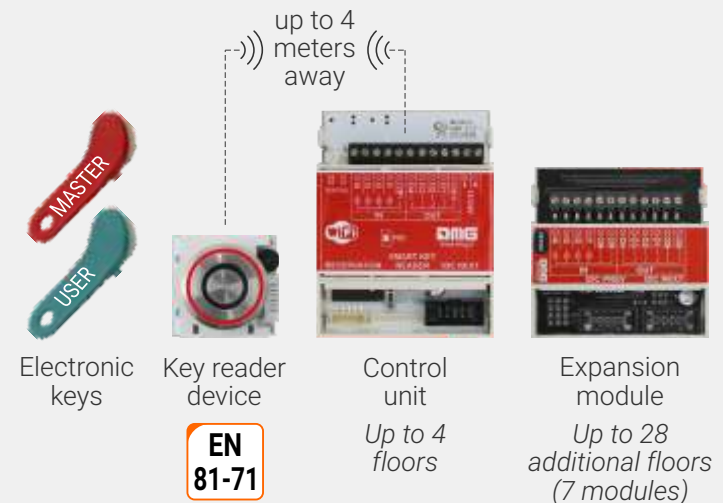

**EN**  
**81-71**



MosaicONE Platform is a secure, cloud-native system that allows registered users from any location to monitor and manage their networked devices from DMG.

- ✓ Schedule building announcements, promote special events and update themes at specific times/days for months in advance
- ✓ Area properties allow you to adjust visibility, positioning, size, color, border of the selected area
- ✓ Design content with anything from images to html content, including per-floor notifications
- ✓ Display areas can be used to create sections on your screen
- ✓ Preview function to check your content before publication
- ✓ Web based THEME EDITOR, no software to install

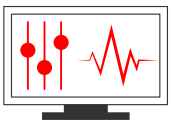

MosaicONE makes it easy to check the status of your devices, access the diagnostics and statistics to have full control over their performances.



You have the control  
Admins can add USERS to buildings and assign ROLES and PERMISSIONS.



Displays can include events, directories, slide shows, news feed, stocks, weather forecast & more!



One place to configure, manage, edit & check your networked devices securely and quickly.

# MATISSE MULTIMEDIA DISPLAY

Visual & Media Systems



With its amazing graphics, cloud-based connectivity, audio and video features, the Matisse multimedia display breaks through the limits of conventional car position indicators by offering the ultimate digital signage experience in your lift.

- ✓ INFOTAINMENT - Matisse displays come as a complete multimedia platform featuring large, high-resolution screens
- ✓ GRAPHIC THEMES - Matisse display features 8 built-in Standard graphic themes, available for all screen sizes
- ✓ CLOUD-BASED SOFTWARE - MosaicONE allows you to manage your own Matisse digital screens with few clicks
- ✓ LIVE+ - An integrated video surveillance system for lifts. It allows the monitoring of landing areas (only delivered with Pitagora 4.0)
- ✓ INTERFACES & OTHER FEATURES - Use Matisse with any elevator with our parallel or serial interfaces and more features

- ✓ Video & background music playback
- ✓ Configurable EN81-70 signal inputs
- ✓ USB/IP CAMERAS connection
- ✓ Built-in clock with backup battery
- ✓ USB and micro SD card inputs
- ✓ Energy saving mode
- ✓ 65.000 colours
- ✓ HDMI output to external LCD screen
- ✓ Advanced voice annunciator
- ✓ Pictures, audios and short videos associated to each floor
- ✓ Full graphic configuration through our cloud based "MosaicONE" software
- ✓ Multicode piloting through 3 dedicated interfaces (Multiparallel, serial or CAN BUS)
- ✓ Connected widgets: weather forecast, local traffic info, newsfeed
- ✓ Compliant EN81-72 (7")

7"	10.1"	15.6"	21.5"
154x86mm 1024x600px	125x223mm 600x1024px	344x194mm 1080x1920px	477x268mm 1080x1920px

▀ Portrait & Landscape

IP44

# MATISSE MIRAGE

Visual & Media Systems



# MATISSE TOUCH

Visual & Media Systems



Enjoy an unprecedented experience using the world's most popular means of transportation

- ✓ OPEN A VIRTUAL WINDOW TO THE OUTSIDE  
Turn your lift into a panoramic elevator! When the lift is in motion, a high-definition video scrolls following the direction of travel. The result is magical.
- ✓ IN A SHOPPING CENTRE  
Display carefully selected information and promotions, that will prepare users for their purchase.
- ✓ IN A HOTEL  
Prepare for an exceptional evening not to be missed.
- ✓ IN AN ART GALLERY  
Guide the visitors through the exhibition, give them information and display your exhibitions calendar.
- ✓ SCREEN SIZE AS DESIRED: 30", 40", 50", 65", 75", 85"

IP44



Matisse Touch gives a fresh new style to the lift cabin and enhances the interaction with users

- ✓ Easier to clean and sanitize
- ✓ Easier to refresh
- ✓ Fancier ride experience
- ✓ More resistant to shocks
- ✓ More durable over time

- Typical layouts are:
- ✓ SPLIT SCREENS,  
featuring two high-res screens, one for the position indicator and one for the Touch Screen.
- ✓ ALL IN ONE,  
featuring a single screen, positioned higher in the car panel, for both position indicator and touch button purposes.



29"  
196x698mm  
540x1920px

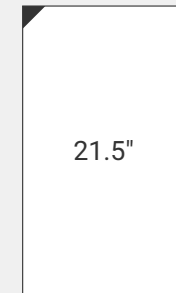

21.5"  
477x268mm  
1080x1920px

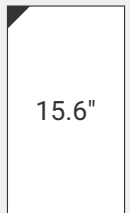

15.6"  
344x194mm  
1080x1920px

Portrait & Landscape

IP44



The MATISSE DIGITAL SIGNAGE brings the elevator notice board into the 21st century

- ✓ Matisse DSD comes with a 15.6" screen.
- ✓ Bigger sizes are available on request.
- ✓ Visible area size: 193x343 mm  
Screen resolution: FullHD 1920x1080 px
- ✓ It is available 50mm or 23mm thick.
- ✓ The H50 version is surface mounted (projecting from the wall surface), whereas the H23 can be mounted surface or flat.
- ✓ The Matisse DSD can be mounted either ways, horizontally and vertically.



IP44

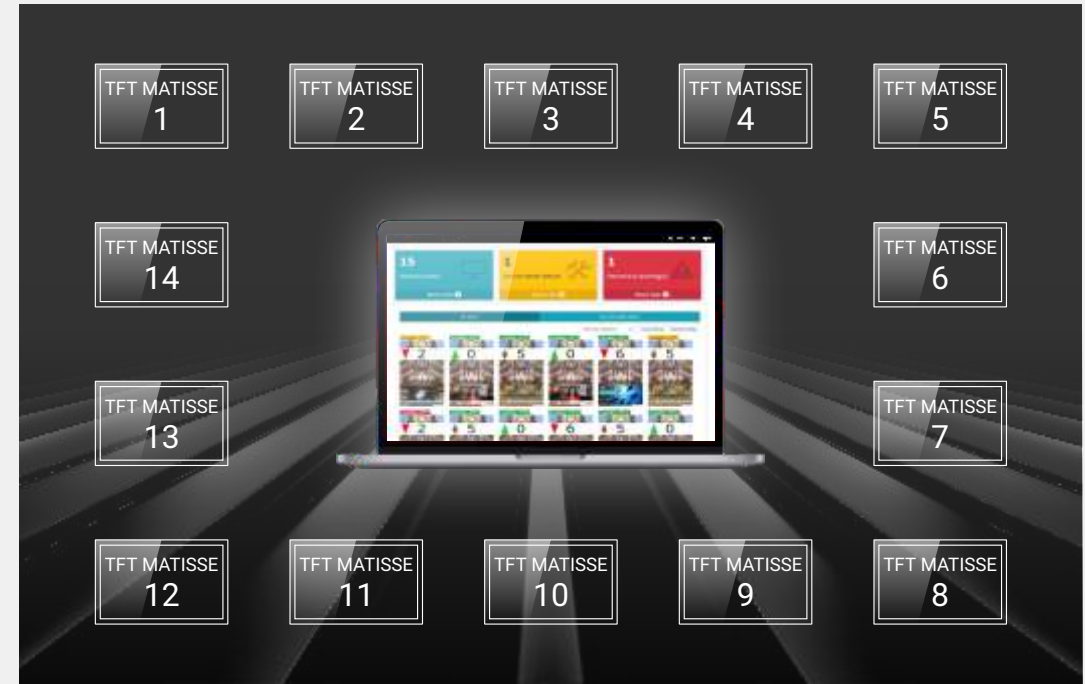

The DMG solution for managing and updating the contents of Matisse displays where Internet access is not possible

- ✓ This solution allows easy updating of Matisse displays located within the same building, taking advantage of the characteristics of a "closed" network.

**What you need?**



A mini PC containing the Media-HUB software to manage Matisse displays.



A switch device to connect the mini PC to the Matisse displays via ETH cables (up to 14 Matisse displays simultaneously).



A PC for the first configuration of Matisse displays (Not provided)

IP44



Discover how colour can change the simple experience of an elevator ride.  
All the features you want from a position indicator, plus the pleasure of stunning colours!

- ✓ AMAZING GRAPHICS! - Giotto is ultra vivid color & graphics in your lift!
- ✓ Giotto can play different audio messages for the elevator users
- ✓ One Giotto, three different interfaces for the connection to any controller!
- ✓ Vandal resistant version (EN81-71 class 2) for 4.3" and 7"
- ✓ EN81-72 compliant (5.6" and 7")
- ✓ Multicode piloting through 3 dedicated interfaces (Multiparallel, serial, CAN BUS)
- ✓ EN 81-70 H.L. Indicators inputs
- ✓ Pictures and audios associated to each floor
- ✓ Voice annunciator
- ✓ 65.000 colours
- ✓ Energy saving
- ✓ Easy configuration with Mosaic PC software

4.3"

95x54mm  
480x272px

5"

111x63mm  
480x272px

5.6"

113x85mm  
640x480px

7"

154x86mm  
1024x600px

10.1"

125x223mm  
600x1024px

Portrait & Landscape

5.6"  
Retrofitting

134x134mm

IP44



Beauty and technology with a competitive price  
All DMG's style in this versatile and cost conscious position indicator

- ✓ Multiple font/background colour combinations associated to each floor
- ✓ Raffaello can display either solid colour background or a gradient style background
- ✓ Designed to fit the cut-outs of some of DMG's best-selling displays
- ✓ Multicode piloting through 3 dedicated interfaces (Multiparallel, serial, CAN BUS)
- ✓ Energy saving
- ✓ Gong (5" / 4.3" version only)
- ✓ Vandal resistant version (EN81-71 class 2) for 2.8" and 4.3"

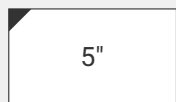

111x63mm  
480x272px



95x54mm  
480x272px



58x43mm  
320x240px



41x31mm  
320x240px

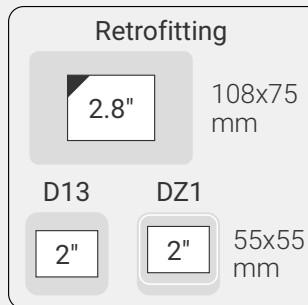

**IP44**

Portrait & Landscape



Strikingly simple and modern, BANKSY is the new ultra-flat front-mounted display series for contemporary fixtures

- ✓ For displays at floors: the screen is equipped with symbols such as Alarm bell, Car at floor (55x55 and 68x71 versions only), Out of service.
- ✓ For displays in the lift car: the screen is equipped with typical EN81-70 symbols Alarm sent, Communication established, Overload.
- ✓ The Banksy is designed to fit the cut-outs of some of DMG's best-selling displays.
- ✓ BANKSY displays are designed as multiparallel devices and can be connected to new and existing controllers in one of the following ways:  
3 wires serial DMG, 1 line per floor, 1 line per segment, Gray, Binary.
- ✓ The BANKSY DB3 and DB4 can be completed with same sized capacity plates.

DB4



147x86mm

DB3



139x77mm

DB2



68x71mm

DB1



55x55mm

**IP4X**

# MURANO

Fixtures



- ✓ White or black 4mm tempered glass, fixtures steel back frame
- ✓ Two solutions: flush mounting or surface mounting
- ✓ The glasses of the Murano line are thermally tempered according to the EN 12150 standard
- ✓ Enhanced Capacitive Touch/Touchless Buttons: immediate response, brights colors, twin Illumination

LxH	250	320(*)(**)	335(*)(***)	1000	1095(*)	1900	2115
90	•	•	•				
130	•	•	•				
220				•	•	•	•

Also wall mounting version (with wall box)  
 (\*) With a metal extension for service keys  
 (\*\*) Flush mounting only  
 (\*\*\*) Surface mounting only  
 Version with upper ceiling

- ✓ Our Murano with front-mounted round Dardo buttons is available on request

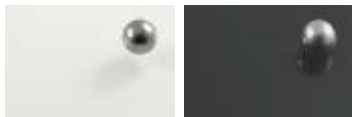

White glass    Black glass

Other glass colors available on request

# FLAT FACEPLATES

Fixtures



- ✓ Softly rounded corners for an enhanced elegant touch
- ✓ 1.5 / 2 / 3mm thickness
- ✓ Fixings: traditional screws, Torx screws, hidden welded studs
- ✓ ARTE profiles for top and bottom endings

LxH	150	200	250	300	350	400	500	600	700 ÷ 1200	1300 ÷ 1500
60	•	•	•	•	•					
80	•	•	•	•	•	•	•			
90		•	•	•	•	•	•	•		
130					•	•	•	•	•	
180						•	○	○	○	
220						•	○	○	○	○
280						•	○	○	○	○

○ Back boxes also available with hinge opening (left side)

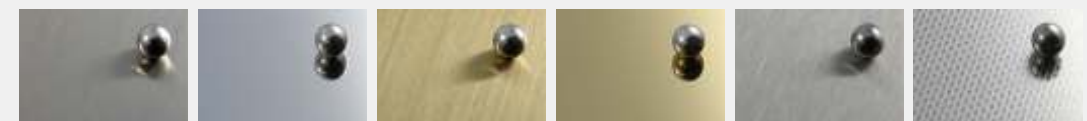
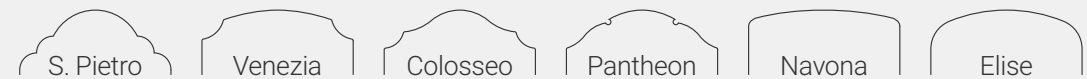

Scotch-brite    Mirror    Brushed PVD    Polished PVD    G320    Lino



# CUT

Fixtures



- ✓ Surface mounted panels with shaped screen insert
- ✓ New fixing method snapped on sub-plate (LOP) or by anchoring with two side hinges (COP)
- ✓ Flat Scotch Brite stainless steel top/bottom endings (1,5mm)

LxH	225	245	290	335	355	500	600	800	900	1000	1200
90	•	•	•	•	•	•					
160							•	•	•	•	
200							•	•	•	•	•

With Raffaello 4,3" if used as indicator panel

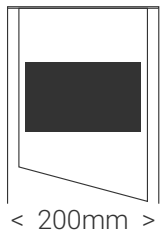

Giotto 7"  
Matisse 7"

< 200mm >

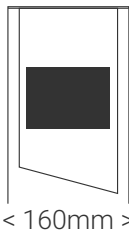

Giotto 5,6"

< 160mm >

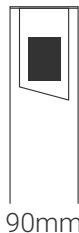

Raffaello 2,8"

< 90mm >



Scotch-brite

# LUNA

Fixtures



- ✓ Surface mounted panels, featuring smooth rounded sides
- ✓ New fixing method snapped on sub-plate (LOP) or by anchoring with two side hinges (COP)
- ✓ Flat Scotch Brite stainless steel top/bottom endings (1,5mm)

LxH	160	225	245	290	335	355	500	600	800	900	1000	1200
70	•	•	•	•								
90	•	•	•	•	•	•	•					
160								•	•	•	•	
200								•	•	•	•	•

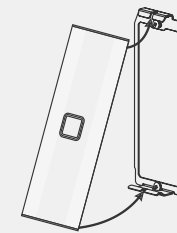
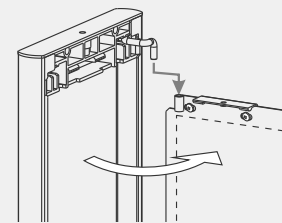

Scotch-brite

# GRETA

Fixtures



- ✓ Floor panels available with top/bottom endings in brushed metal or black plastic (H16,5 mm)
- ✓ COP metal top ending and black plastic bottom ending with recessed edge
- ✓ Greta Ambient - The Backlight option on the plate sides, available on request

## 23 mm deep versions

LxH	160	225	245	290	335	355	500	600	700	800	900	1000	1100	1200
65	•	•	•	•										
85	•	•	•	•	•	•	•							
160								•	•	•	•	•	•	•
200								•	•	•	•	•	•	•

## 16,5 mm deep versions (not available in PVD versions)

LxH	200	240
70	•	•
100	•	•



Scotch-brite    PVD black    PVD bronze

# SILVERLIGHT

Fixtures



- ✓ Quick mounting without visible screws
- ✓ 23mm-thick rounded profile
- ✓ ABS end caps (brushed nickel or gold PVD colors)

LxH	227	250	300	357	407	507	607	707	807	907	1000	1107	1207	1950
100	•	•	•	•	•	•	•	•	•	•				
200					•	•	•	•	•	•	•	•	•	•

Car column version —┐



Scotch-brite    Mirror    Brushed PVD    Polished PVD

# VENUS

Fixtures



- ✓ Full height column for lift cabins
- ✓ Full height fixed panel or flap opening (locking can be either with a key or hidden)
- ✓ The flap opening model is openable in 2 or 3 parts
- ✓ Flush mounted or protruding from the wall

LxH	2000	2010	2020	(*)	2380	2390	2400	(*) 10 mm steps
200	•	•	•	•	•	•	•	
210	•	•	•	•	•	•	•	
250	•	•	•	•	•	•	•	

For non-standard widths please contact our sales department

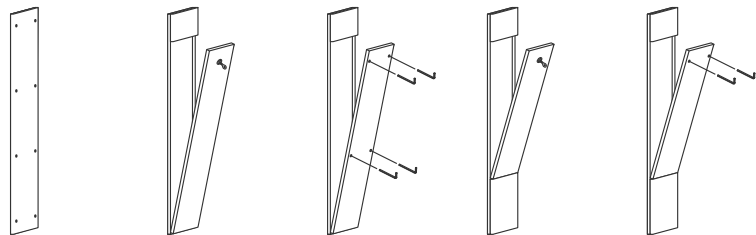

Scotch-brite    Mirror    Brushed PVD    Polished PVD    G320    Lino

# HANDY

Fixtures



- ✓ Horizontal operating panel for increased accessibility
- ✓ Frontal hinge opening
- ✓ Side terminals in st/steel with polycarbonate borders

LxH	500	600	1000
191,5	•	•	•
Max stops	Ⓐ 4	5	10
	Ⓑ 6	8	18

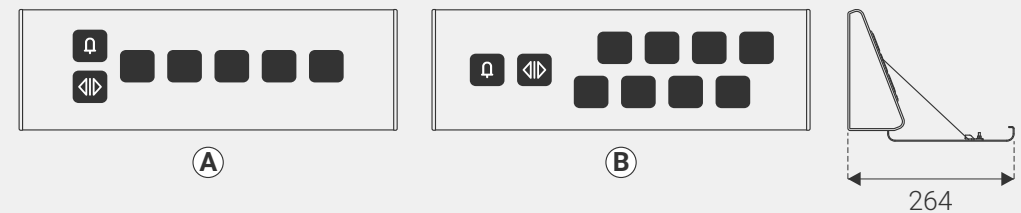

Scotch-brite

# EN 81-71

Fixtures



## VANDAL-PROOF solutions

- ✓ 2 or 3 mm faceplates with welded studs
- ✓ Impact test and Fire test compliant
- ✓ Portrait & Landscape



TFT Raffaello  
2,8"

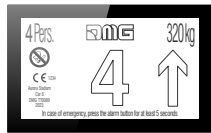

TFT Giotto  
4,3"

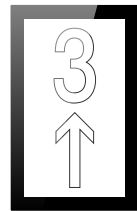

TFT Raffaello  
4,3"

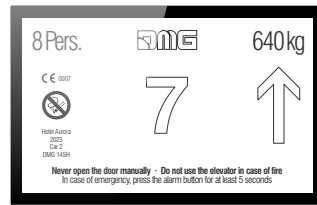

TFT Giotto  
7"

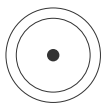

Panzer

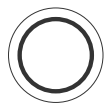

Sherman



Dardo  
(square)



Dardo  
(round)

**EN 81-71** class 2  
TFT Raffaello / Giotto  
Panzer / Sherman

**EN 81-71** class 1  
Push-button  
Dardo

# EN 81-72

Fixtures



## FIREFIGHTERS solutions

- ✓ 2mm Scotch-Brite faceplates with screw fixing and IPX3 back box + wall fixing box
- ✓ Display: TFT Giotto 5,6"/7" (car), Raffaello 2,8"/4,3" (floors)
- ✓ Push-buttons: Panzer / Sherman / Dardo
- ✓ Triangular 2C waterproof key switch
- ✓ Floor intercom (italian DM15/09/2005 compliant)



130x300

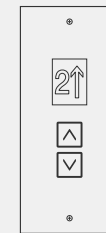

130x300

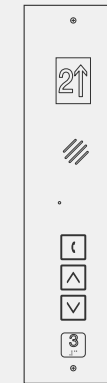

130x500



130x500

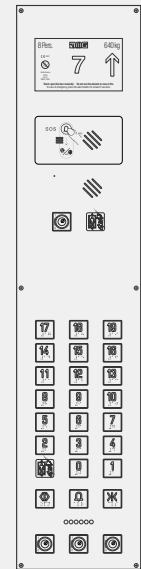

220x1000

**EN 81-72** 2015

**D.M. 15/09** 2005

# PITAGORA 4.0

Electric systems for LIFTS

# JUNIOR 4.0

Electric systems for HOMELIFTS

EN 81-1/2 EN 81-20 EN 81-50



EN 81-41 pr EN 81-42

Its intelligent, versatile, and flexible TECHNOLOGY is designed to make life easier for users, building owners, and lift technicians.



The ELGO-safe "ABSOLUTE ENCODER" is the best car positioning solution for more demanding applications. It adopts a magnetic band to accurately measure the position and speed of the car in the shaft.

Available only for Pitagora 4.0



DMG Motherboard and Fuji LM2 VVVF inverter integrated into a single device. With its robust hardware and advanced 32-bit software, Pitagora 4.0 is designed to meet and exceed the requirements of the EU Lift Directive.

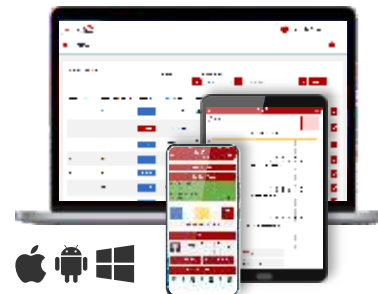

**FUSION** is DMG's cloud-based platform that enables remote, real-time monitoring of lifts equipped with Pitagora/Junior 4.0 connected electric system. Fusion can also connect to the lift controller locally, using the Wifi-Bluetooth interface.



Thanks to **pre-wired components** with serial bus communication technology, DMG products ensure efficient installation times. Pre-wired components allow quick replacements and simpler retrofit.



Pitagora 4.0 software includes many **built-in functions** designed to make life easier to users and to improve the perceived safety.

 This publication provides general information only.  
Product design may change without prior notice.  
Actual product colors and finishes may vary.

 All measurements are in mm.



